



Fluid Power Pneumatic Division

SOLENOID VALVES

200 SERIES

5 port, 4 way

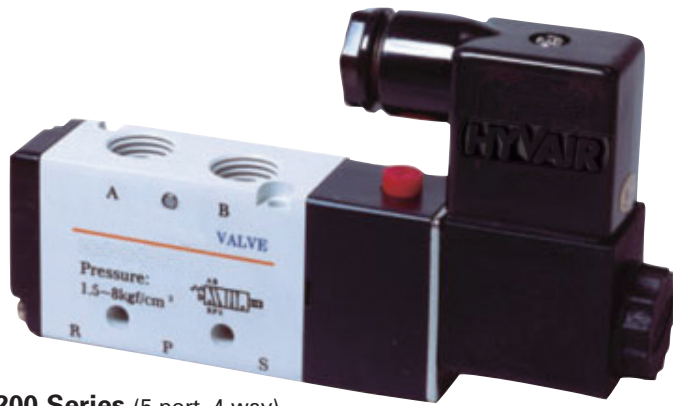

200 Series (5 port, 4 way)

SPECIFICATIONS

Media	Air (No other gases or liquids)
Operation	Solenoid (Direct Acting)
Function	5 port, 4 way
Operating Temp. Range	41 - 140°F (5 - 60°C)
Maximum Pressure	10.5 Kg/cm ² (150psi)
Working Pressure	1.5 - 8.0 Kg/cm ² (21-114psi)
Orifice	12 mm ² - 16 mm ²
Flows	
Lubrication	None Required
Maximum Cycle Rate	5 cycles/second
Insulation	Class F
Power Consumption	AC: 4.5VA DC: 3.0W

SYMBOL



5 port, 4 way, 2 position
(spring return,
single solenoid)



5 port, 4 way, 2 position
(detented,
double solenoid)

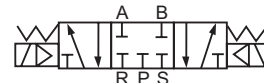

5 port, 4 way, 3 position
(spring centered blocked,
double solenoid)

FLOW DATA

SV202 1/8"

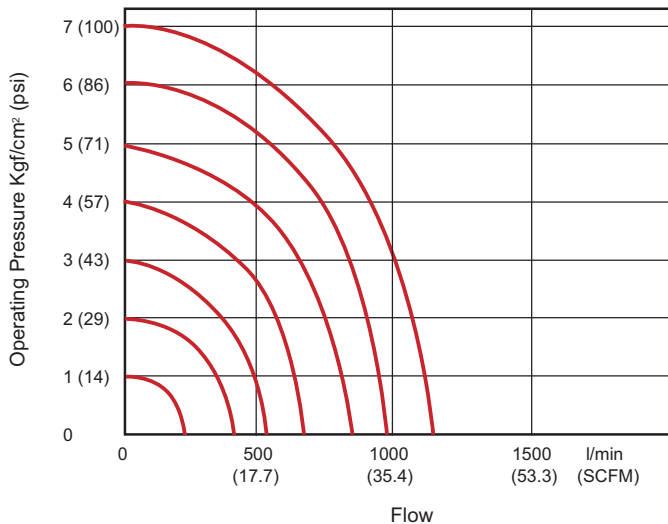

SV204 1/4"

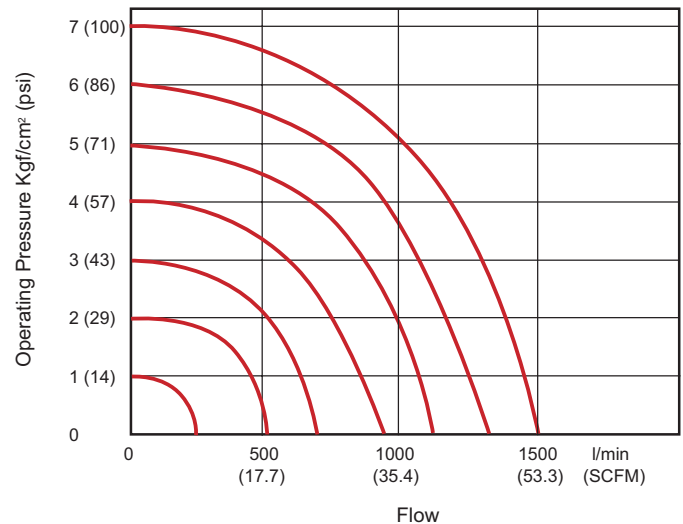

200 SERIES

5 port, 4 way

CONSTRUCTION MATERIAL

Name	Material			Name	Material		
	542S	542D	543B		542S	542D	543B
Body	Aluminum Alloy			Fixed Plate	Nickel Plated Steel		
Spool	Aluminum Alloy			Nut	Plastic		
Manual Override O-Ring	NBR			Manual Override	Plastic		
Connector Gasket	NBR			Bottom Cover	NBR		
Spool O-Ring	HNBR			Manual Override Spring	Stainless Steel		
Bottom Cover Gasket	NBR			Spool Spring	Stainless Steel		
Pilot Gasket	NBR			Pilot Body	PBT+Glass Fiber		
Connector	Plastic			Fixed Screw	Iron		
Return Holder O-Ring			NBR	Coil Cover	Heat-Resistant Resin		
Return Kit			Copper	Manifold	Aluminum Alloy		
Side Cover			Aluminum Alloy	Piston	Plastic		
Return Spring			Stainless Steel	Armature	Pure Iron		
Return Spring Kit			Copper				

PARTS BREAKDOWN

542S

542D

543B

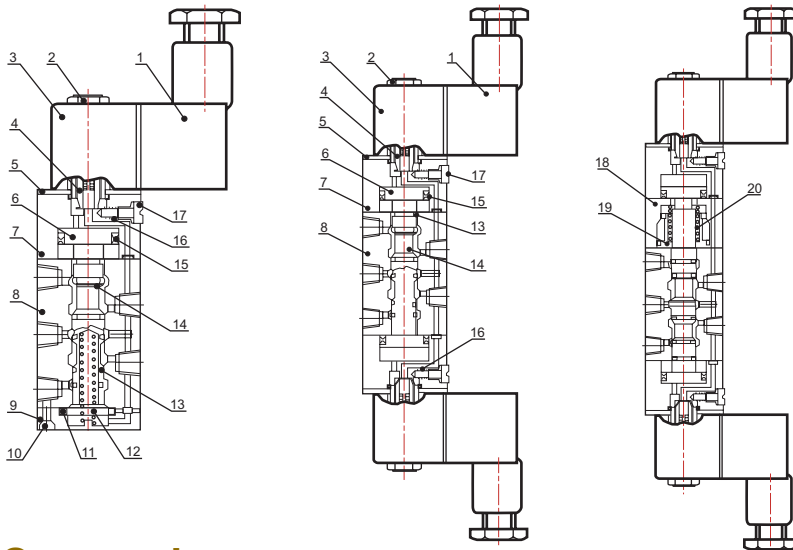

No.	Name	No.	Name
1	Connector	11	Bottom Cover Gasket
2	Nut	12	Spool Spring
3	Coil	13	Spool O-Ring
4	Armature Assembly	14	Spool
5	Fixed Plate	15	Piston O-Ring
6	Piston	16	Override Spring
7	Pilot Kit	17	Manual Override
8	Body	18	Side Cover
9	Bottom Cover	19	Spring Holder
10	Fixed Screw	20	Return Spring

ORDERING INFORMATION

SV - 204 - 542D - 110A - SRL

Code	Description	Model	Port Size	Code	Standard Configurations	Coil Voltage	Code	Electrical Connector
SV	Solenoid Valve	202	1/8"	542S	5 port, 4 way, 2 pos., spring return	omit (none)	omit	none
		204	1/4" (1/8" Exhaust)	542D	5 port, 4 way, 2 pos., detented (double solenoid)	12D (DC)	SR	Strain Relief
				543B	5 port, 4 way, 3 pos., spring centered-all ports blocked (double solenoid)	24A (AC)	CD	1/2" Conduit
						24D (DC)	LW	Lead Wire 36"
						48A (AC)	SRL	Strain Relief-Lighted (standard)
						110A (AC)	CDL	1/2" Conduit-Lighted
						220A (AC)	LWL	Lead Wire 36"-Lighted



Fluid Power Pneumatic Division

SOLENOID VALVES

200 SERIES

5 port, 4 way

DIMENSIONAL DATA

Units: mm/ (Inch)

SV202-542S

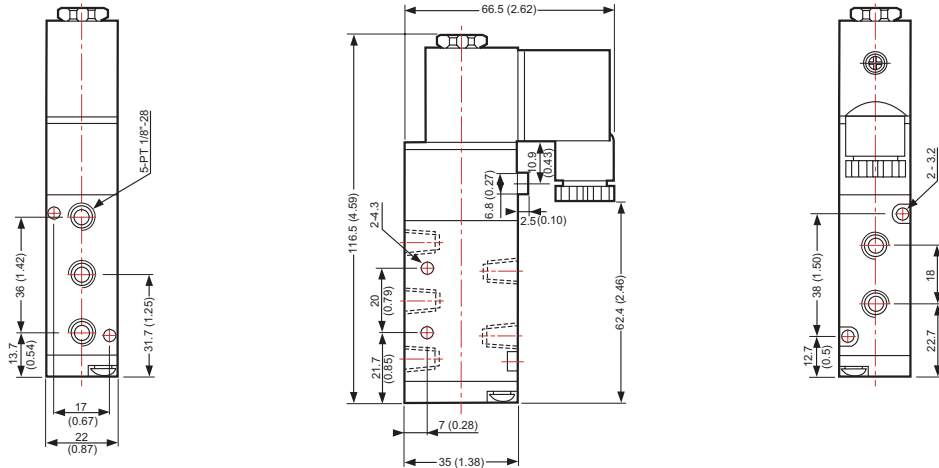

SV204-542S

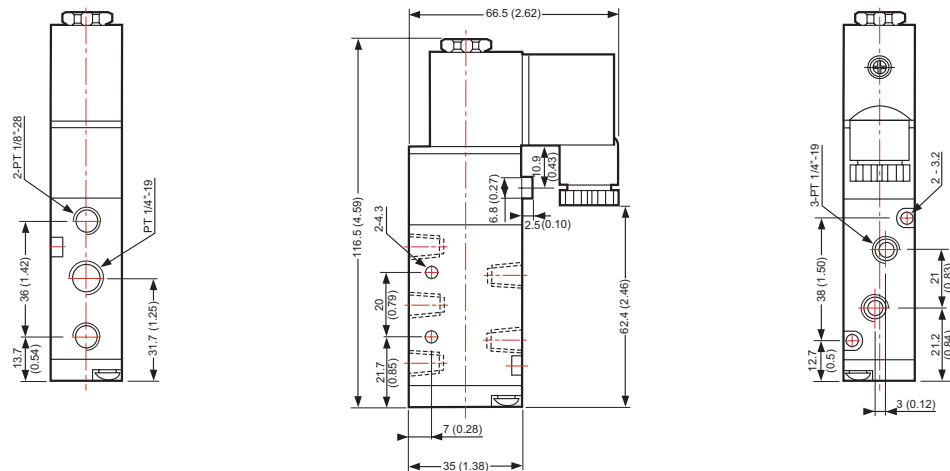

SV202-542D

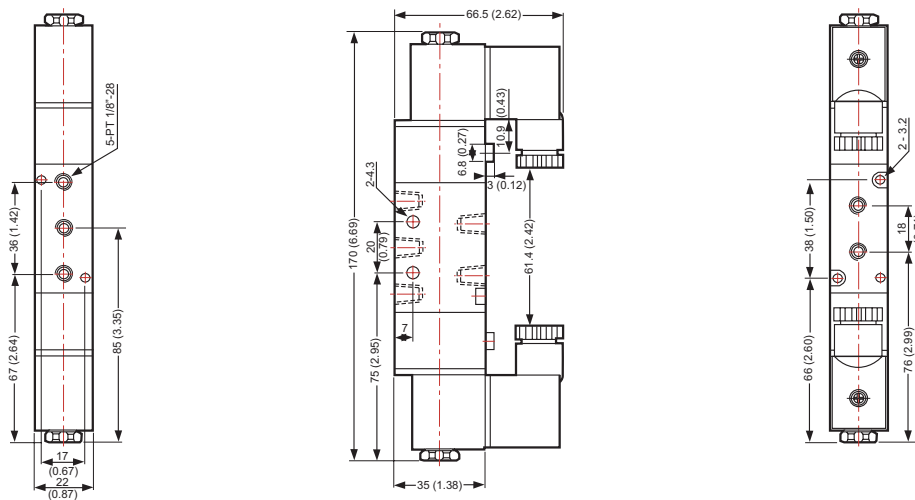

200 SERIES

5 port, 4 way

DIMENSIONAL DATA

Units: mm/ (Inch)

SV204-542D

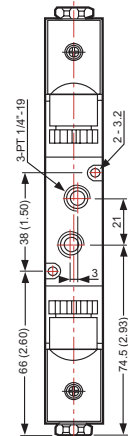
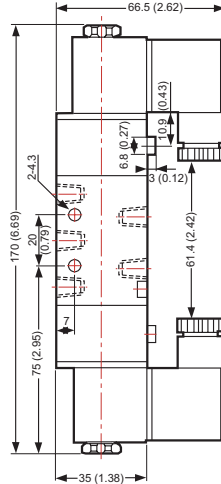
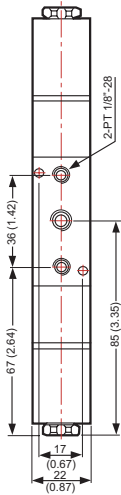

SV202-543B

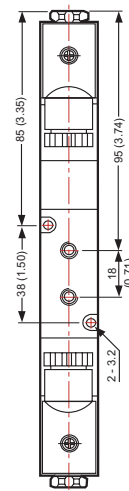
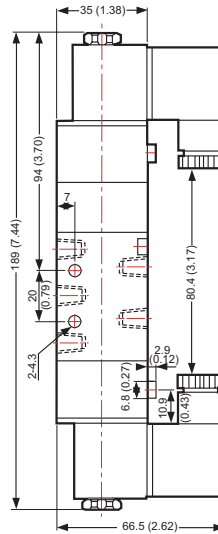
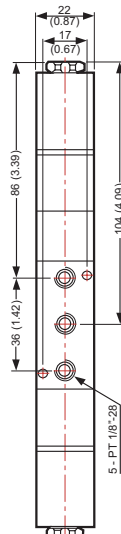

SV204-543B

