



Fluid Power Pneumatic Division

# AIR PILOTED VALVES

## 200 THRU 800 SERIES

1/8" - 1/2" Ports



Air Piloted Valves 1/8" - 1/2" ports

### SPECIFICATIONS

Media	Air (No other gases or liquids)		
Operation	Direct Air Pilot		
Operating Temp. Range	41 - 140°F (5 - 60°C)		
Maximum Pressure	135psig (9.3 bar)		
Working Pressure	20-100 psig (1.4-6.9 bar)		
Flows	Two Position	Three Position (spring centered)	
	AV-202 (1/8")	Cv=0.7	Cv=0.6
	AV-204 (1/4")	Cv=0.8	Cv=0.6
	AV-404 (1/4")	Cv=1.4	Cv=1.0
	AV-406 (3/8")	Cv=1.6	Cv=1.0
AV-808 (1/2")	Cv=2.7	Cv=1.6	
Lubrication	None Required		
Maximum Response Time	Pilot 30ms @80 psi/ Spring- 50ms		
Maximum Cycle Rate:			
	Series 200	5 cycles/second	
	Series 400	4 cycles/second	
	Series 800	3 cycles/second	

### DIMENSIONAL DATA

Units: mm/ (Inch)

#### 200 SERIES 1/8", 1/4"

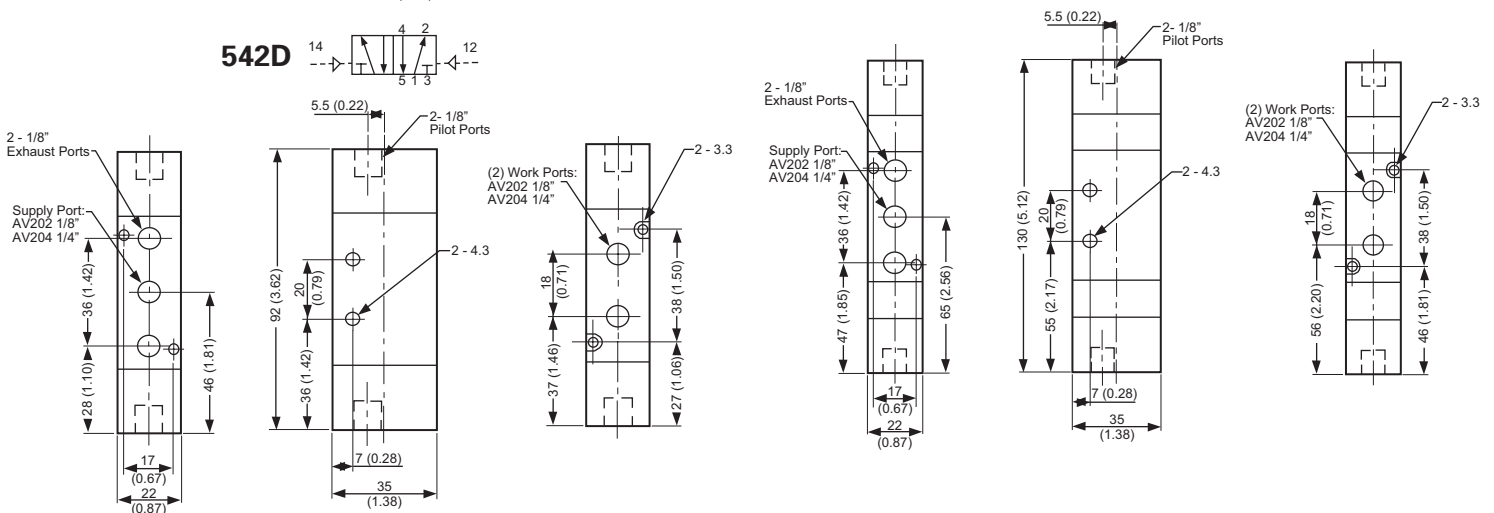
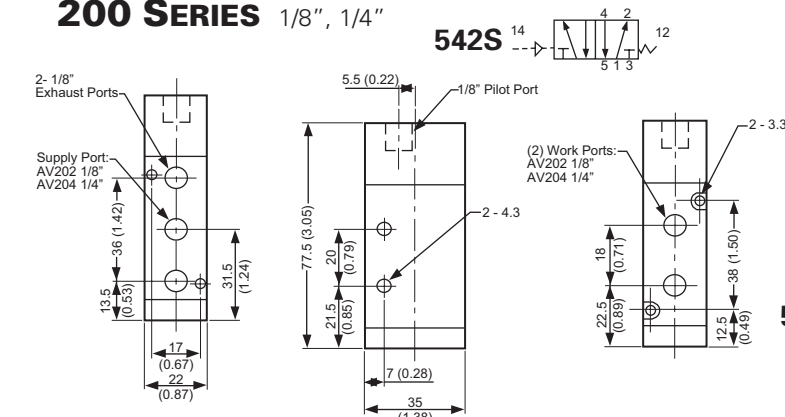

### FEATURES

- Available: 1/8", 1/4", 3/8", and 1/2" ports.
- All 4-way valves may be manifold mounted.
- U-cup type seals allow low shifting pressures and avoid sticking.
- Anodized aluminum spools.
- Same base valve also available as SV series, solenoid valve.
- Dual porting available in 200/400 series.



200 THRU 800 SERIES

1/8" - 1/2" Ports

DIMENSIONAL DATA

Units: mm/ (Inch)

400 SERIES 1/4", 3/8"

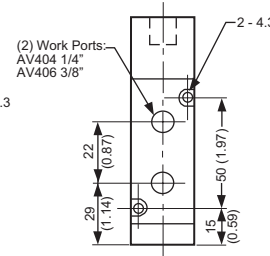
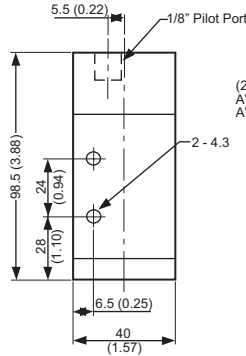
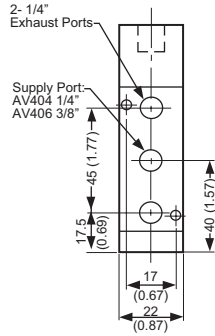
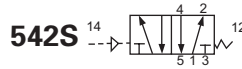

AV404  
AV406

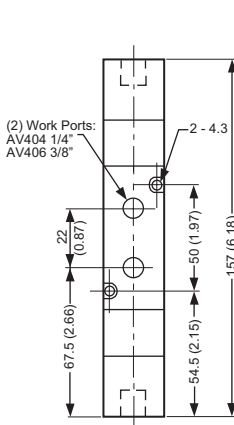
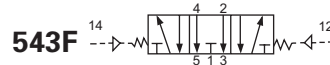
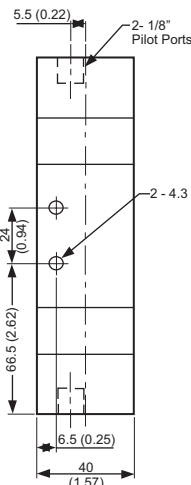
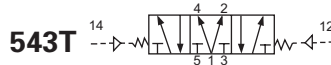
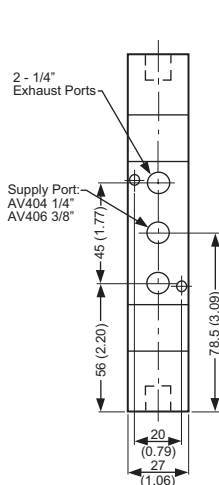
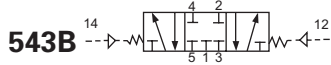
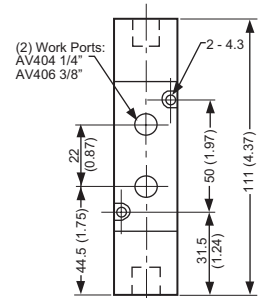
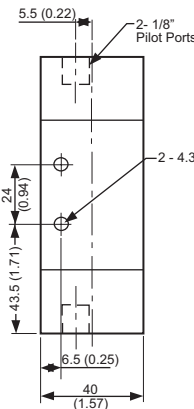
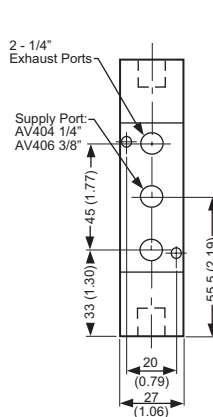
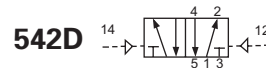



Fluid Power Pneumatic Division

# AIR PILOTED VALVES

## 200 THRU 800 SERIES

1/8" - 1/2" Ports

### DIMENSIONAL DATA

Units: mm/ (Inch)

#### 800 SERIES 1/2"

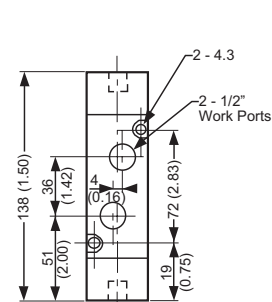
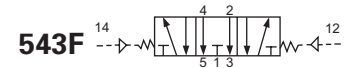
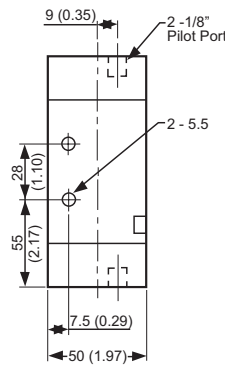
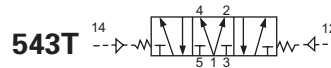
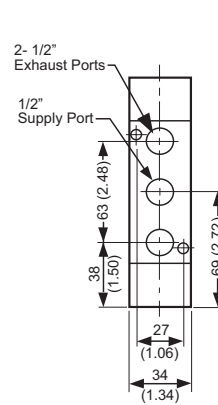
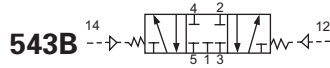
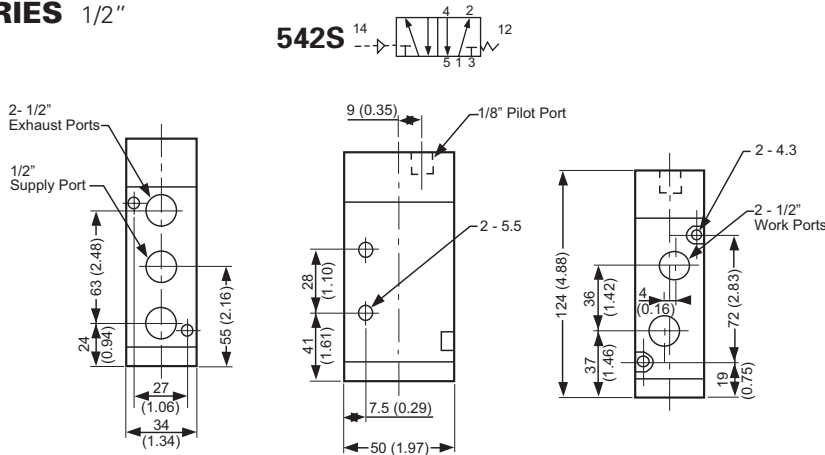

### ORDERING INFORMATION

#### AV - 404 - 542S

Code	Description
AV	Air Piloted Valve

Size	Description
202	1/8" Ports
204	1/4" Ports (1/8" Exhaust)
404	1/4" Ports
406	3/8" Ports (1/4" Exhaust)
808	1/2" Ports

Code	Configurations
542S	5 port, 4 way, 2 pos., spring return (single pilot)
542D	5 port, 4 way, 2 pos., detented double pilot
543B	5 port, 4 way, 3 pos., spring centered-all ports blocked (double pilot)

See dimensional information for other 543 spools available.